

POWER THEFT DETECTION & INITIMATE ENERGY METER INFORMATION ON THROUGH SMS WITH AUTO POWER CUT OFF

¹Matam Shashirekha, ²Rachamalla Sukanya, ³Badugu Leela Priyamvada, ⁴Gudipati Nizamuddin

¹²³⁴Assistant Professor

Department Of EEE

Tadipatri Engineering College, Tadipatri, AP

Abstract

Electrical energy is very imperative for ever day life and a spine for the industry. Electricity is indiscipline to our daily life with increasing need of electricity the power theft is also increasing power theft is a problem that continues to plague power sector across the whole country the objective of this project is to design a system in order to avoid the displeasure for the users from the fty bill irrespective of the use of the electricity due to theft using GSM module. The proposal in this project is to monitor the power theft and informing the power theft trough sms. Monitoring the power means calculating the power consumed exactly by the user at a given time. The power monitored of the meter. It is helps in identifying usages between authorized and unauthorized users which helps in controlling the power theft, one of the major challenges in current scenarios.

I. INTRODUCTION

Electricity theft is a very common problem in country, were population is very high and the use of electricity are ultimately tremendous. In India, every year there is very increasing number of electricity thefts across domestic electricity connection as well as industrial electricity supply, which results in loss of electricity companies energy and because of which we are facing the frequent problems of load shading in urban as well as rural areas so as to overcome the need of electricity for whole state. Also the ways using which theft can be done are innumerable so we can never keep track of how a theft has occurred, and this issue is needed to be solved as early as possible. In This abstract we propose an electricity theft detection system to detect the theft which is a made by the most common way of doing the theft and that is bypassing the meter using the a piece of wire, people simply bypasses electricity meter which is counting the current unit by placing a wire before and after the meter reading unit. The proposed system will be hidden in such meter and as soon as an attempt is made for the theft, it will send SMS to control unit of electricity board. In this system current transformer are used, here one current transformer is placed in input side of the post line. Other current transformer are placed at the distribution points of the house lines. The output of CT values is given as input to PIC microcontroller convert analog inputs to digital. Then PIC compares the input current and the same of output current. If compared result has any negative values then this particular post is detected as theft point. This compared value is transmitted to electricity board, this value display in LCD display. The information will then be quickly processed by the microcontroller

and a SMS will be send through the GSM technology.

II. LITERATURE REVIEW

Electricity can be produced through many ways which is then synchronized on a main grid for usage. The main issue for which we have written this survey paper is losses in electrical system. In et al [2] M.V.Ramesh This design incorporates effective solutions for problems faced by India's electricity distribution system such as power theft and transmission line fault, In et al [3] ZHOU Wei, electricity-stealing prevention became a big problem to the electricity board. Based on the kind of electricity-stealing and actual demand of prevention of stealing electricity, realizes the behaviour of electricity-stealing with remote monitoring . In et al [4] H.G.Rodney, this paper presents of design and development of Automatic meter reading (AMR) system. AMR system is a boom for remote monitoring and control domestic energy meter. In et al [5] Amin S. Mahmoud, This paper deals with automatic meter reading and theft control system in energy meter. This model reduces the manual manipulation work and theft control.

III. DESIGN OF HARDWARE

This chapter briefly explains about the Hardware implementation of Power theft identification. It discuss the circuit diagram of each module in detail.

3.1. ARDUINO UNO

The Arduino Uno is a microcontroller board based on the ATmega328 (datasheet). It has 14 digital input/output pins (of which 6 can be used as PWM outputs), 6 analog inputs, a 16 MHz ceramic resonator, a USB connection, a power jack, an ICSP header, and a reset button. It contains everything needed to support the microcontroller; simply

connect it to a computer with a USB cable or power it with a AC-to-DC adapter or battery to get started.

The Uno differs from all preceding boards in that it does not use the FTDI USB-to-serial driver chip. Instead, it features the Atmega16U2 (Atmega8U2 up to version R2) programmed as a USB-to-serial converter. Uno board has a resistor pulling the 8U2 HWB line to ground, making it easier to put into DFU mode. Arduino board has the following new features:

- 1.0 pinout: added SDA and SCL pins that are near to the AREF pin and two other new pins placed near to the RESET pin, the IOREF that allow the shields to adapt to the voltage provided from the board. In future, shields will be compatible both with the board that use the AVR, which operate with 5V and with the Arduino Due that operate with 3.3V. The second one is a not connected pin, that is reserved for future purposes.
- Stronger RESET circuit.
- Atmega 16U2 replace the 8U2.

"Uno" means one in Italian and is named to mark the upcoming release of Arduino 1.0. The Uno and version 1.0 will be the reference versions of Arduino, moving forward. The Uno is the latest in a series of USB Arduino boards, and the reference model for the Arduino platform; for a comparison with previous versions, see the index of Arduino boards.

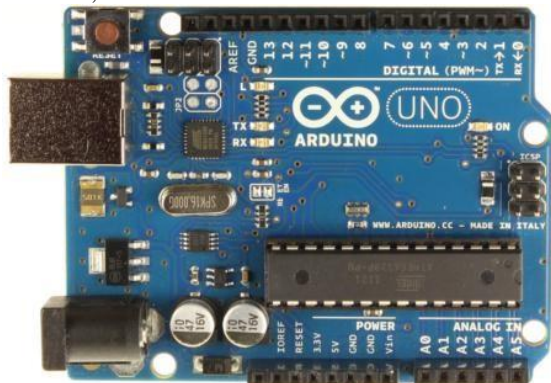

Fig: ARDUINO UNO

3.2. POWER SUPPLY

The power supplies are designed to convert high voltage AC mains electricity to a suitable low voltage supply for electronic circuits and other devices. A power supply can be broken down into a series of blocks, each of which performs a particular function. A d.c power supply which maintains the output voltage constant irrespective of a.c mains fluctuations or load variations is known as "Regulated D.C Power Supply".

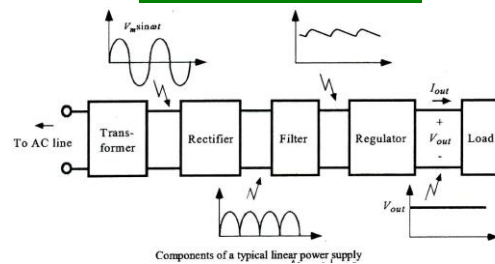
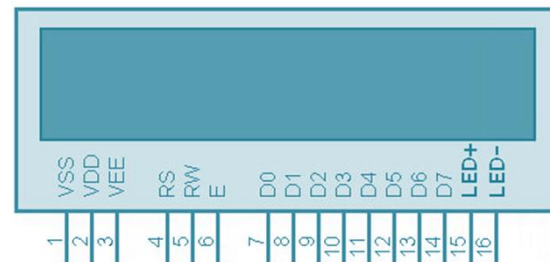

Fig:Power Supply

3.3 LCD

Liquid Crystal Display also called as LCD is very helpful in providing user interface as well as for debugging purpose. The most commonly used Character based LCDs are based on Hitachi's HD44780 controller or other which are compatible with HD44580. The most commonly used LCDs found in the market today are 1 Line, 2 Line or 4 Line LCDs which have only 1 controller and support at most of 80 characters, whereas LCDs supporting more than 80 characters make use of 2 HD44780 controllers



3.4 RELAYS

We know that most of the high end industrial application devices have relays for their effective working. Relays are simple switches which are operated both electrically and mechanically. Relays consist of a n electromagnet and also a set of contacts. The switching mechanism is carried out with the help of the electromagnet. There are also other operating principles for its working. But they differ according to their applications. Most of the devices have the application of relays.

The main operation of a relay comes in places where only a low-power signal can be used to control a circuit. It is also used in places where only one signal can be used to control a lot of circuits. The application of relays started during the invention of telephones. They played an important role in switching calls in telephone exchanges. They were also used in long distance telegraphy. They were used to switch the signal coming from one source to another destination.

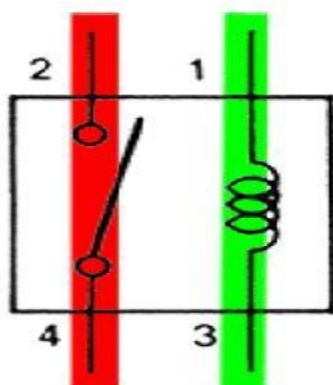
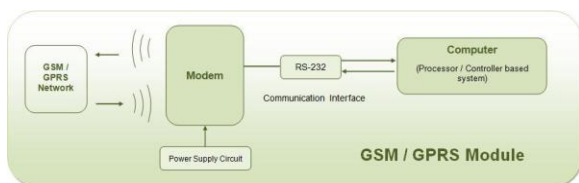

Fig: relay

3.5GSM Modem

A GSM modem is a device which can be either a mobile phone or a modem device which can be used to make a computer or any other processor communicate over a network. It can be connected to a computer through serial, USB or Bluetooth connection. A GSM modem can also be a standard GSM mobile phone with the appropriate cable and software driver to connect to a serial port or USB port on your computer.

GSM/GPRS module is used to establish communication between a computer and a **GSM-GPRS system**. **Global System for Mobile communication (GSM)** is an architecture used for mobile communication in most of the countries. **Global Packet Radio Service (GPRS)** is an extension of GSM that enables higher data transmission rate. **GSM/GPRS module consists of a GSM/GPRS modem assembled together with power supply circuit and communication interfaces** (like RS-232, USB, etc) for computer. The MODEM is the soul of such modules.



Wireless MODEMS

Wireless MODEMS are the MODEM devices that generate, transmit or decode data from a cellular network, for establishing communication between the cellular network and the computer. These are manufactured for specific cellular network (GSM/UMTS/CDMA) or specific cellular data standard (GSM/UMTS/GPRS/EDGE/HSDPA) or

technology (GPS/SIM). Wireless MODEMS like other MODEM devices **use serial communication** to interface with and need **Hayes compatible AT commands** for communication with the computer (any microprocessor or microcontroller system).

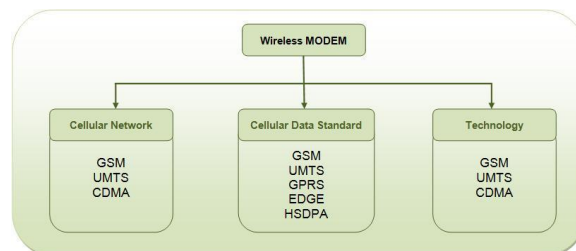

IV. PROJECT DESCRIPTION

BLOCK DIAGRAM:

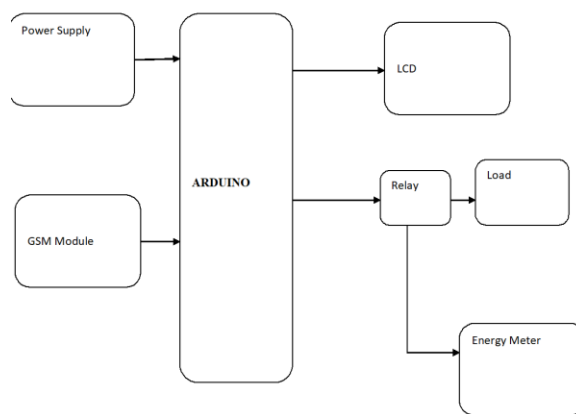

Fig : block diagram

WORKING:

The aim of this project is to detect the power theft and intimation to electricity board about meter information through SMS and disconnect the power to loads when power theft is detected. Electricity theft is at the centre of focus all over the world but electricity theft in India has a significant effect on the Indian economy, as this figure is considerably high. Ineffective and inefficient present methods of detecting and preventing Power theft cause a revenue loss along with damage to personal and public property. Large amount of power shortage is caused

due to power theft. One of the challenges in stopping power theft is the difficulty in detecting power theft. In particular it is difficult to find the exact location where power theft is occurring. Measurement of parameters like power line current and power line voltage has not been available in a satisfactory way to optimize power network management but due to advancement in present technologies we can give better solution to detect the power theft. In our system, a micro controller is interfaced with an energy metering circuit, current sensing circuit, GSM modem and a contactor to make or break power line. In normal condition, micro controller reads energy pulses & current signals. If current is drawing & energy pulses are normal, then no power theft is being done & the o/p is connected. If current is drawing & energy pulses are not coming, then it indicates power theft. Whenever power theft is detected, then micro controller will send this meter information to electricity board with meter number, owner details and location at which installed through SMS.

And this controller also disconnects power to the loads to avoid power theft. This project uses regulated 5V, 750mA power supply. 7805 three terminal voltage regulator is used for voltage regulation. Bridge type full wave rectifier is used to rectify the ac out put of secondary of 230/18V step down transformer.

V.CONCLUSION

The project model reduces the manual manipulation work and theft. Use of GSM in our system provide the numerous advantages of wireless network systems. The metering IC ensure the accurate and reliable measurement of power consumed. Hence we are trying to manipulate cost wise low when compared to other energy meter without automatic meter reading and theft control.

REFERENCES

- [1] Siddarameswara H.N. "GSM based electricity theft identification in houses and in industry sector", ICEE-21st june 2014, ISBN-978-93-81693-6603-03.
- [2] P. Rakesh Malhotra et al. / IJET "automatic meter reading and theft control system by using GSM", 2013.
- [3] Abhinandan Jain, Dilip Kumar, Jyoti Kedia, "Design and Development of GSM based Energy Meter", in IJERT, 2012.
- [4] S. Arun; Dr, sidappa Naidu, "Design and implementation of automatic meter reading system using GSM, ZIGBEE through GPRS" in international journal of advanced research in computer science engineering, 2012.

[5] Bharath, P.; ananth, N.; Vijetha, S.; Prakash, K.V.J.; "Wireless automated digital energy meter". In sustainable energy technologies, ICSET 2008.

[6] Abdollahi, A. Dehghani, M. Zamanzadeh, "SMSbased Reconfigurable automatic meter reading system" in control applications, 2007.