

MATERIAL VARIATION IN THE HEAD GASKET DESIGN AND THERMAL ANALYSIS

¹Dr. BommanaShravan Kumar, ²Dr. Vodnala Veda Prakash, ³Dr. MuddaNirishyadav

^{1,2,3}Assistant Professor

Department Of Mechanical Engineering

Kshatriya College of Engineering

Abstract: The engine's block and cylinder head are separated by a gasket. Its job is to keep unwanted fluids out of the cylinders and keep the compression levels high. My personal goal for this project is to improve upon the current gasket material and style for four-cylinder engines. Multiple-Layer System (MLS) Asbestos with steel (usually three layers of steel) - MLS gaskets are standard on most newer head engines. Rubber-like coatings, such as Viton, are often used to bind the contact sides to the cylinder block and cylinder head, while the thicker central layer is left uncoated. Gasket producers are looking for alternatives to asbestos because to the health risks posed by breathing in the mineral's tiny fibres. The cylinder head gasket of the 4-stroke engine will undergo a thermal analysis test.

Cylinder head gasket problems may be identified, and alternative gasket materials can be compared, with the use of this investigation. Gasket materials mostly undergo distortion as a result of temperature differences. This article presents the first documented use of ANSYS, a commercial programme for numerical simulation of thermal analysis. Catia software is used to create the gasket diagram. The software's diagram is imported and analysed. Using ANSYS, we compare the performance of these three options and choose the one with the best overall results. Several gasket material variations are used in this project to execute different optimisation strategies. Gasket modelling is accomplished with the use of design software. The thermal and structural characteristics of gasket material have been improved by the use of Finite Element analysis in ANSYS.

Keywords: gasket, transient thermal, catia, and ansys

I INTRODUCTION

A gasket is a mechanical seal which fills the space between two or more mating surfaces, generally to prevent leakage from or into the joined objects while under compression. It is a deformable material that is used to create a static seal and maintain that seal under various operating conditions in a mechanical assembly. Gaskets allow for "less-than-perfect" mating surfaces on machine parts where they can fill irregularities. The engine of an automobile is divided into a cylinder head ("head") and a cylinder block ("block").

A cylinder head gasket ("gasket") is inserted between the head and the block to prevent leaks of the high-pressure combustion gas, cooling water, etc. inside the engine. Its purpose is to seal the cylinders to ensure maximum compression and avoid leakage of coolant or engine oil into the cylinders; as such, it is the most critical sealing application in any engine and, as part of the combustion chamber, it shares the same strength requirements as other combustion chamber components.

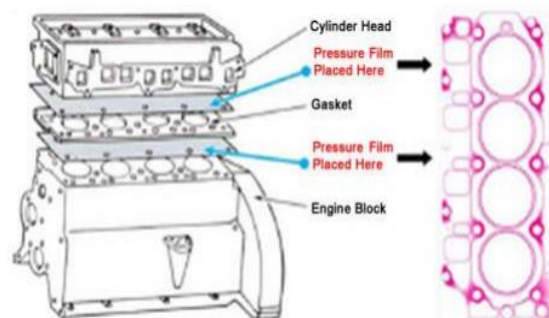

Fig 1:Engine Block

The condition of a head gasket is typically investigated by checking the compression pressure with a pressure gauge, or better, a leak-down test, and/or noting any indication of combustion gases in the cooling system on a water-cooled engine. Oil mixed with coolant and excessive coolant loss with no apparent cause, or presence of carbon monoxide or hydrocarbon gases in the expansion tank of the cooling system can also be signs of head gasket problems.

Gasket Design

Every application requires a unique cylinder head gasket design to meet the specific performance needs of the engine. The materials and designs used

are a result of testing and engineering various metals, composites and chemicals into a gasket that is intended to maintain the necessary sealing capabilities for the life of the engine. Head gasket designs have changed over time to time, and in recent years are changing even faster.

The most widely used materials are as follows:

1. Copper and Asbestos combination.
2. Fiber based composite materials. Graphite in various densities.
3. Combination of Aluminium and Fiber.

Properties of a Gasket used

The gasket material should have good flexibility, low density, and high tensile strength. It should also have a resistance to chemicals and internal pressure, and durability. It must also have excellent adhesion properties with itself and anything it touches. Excellent wear resistance. Good bonding strength. Not as ideally suited to mechanical, weathering and chemical resistance.

II LITERAURE STUDIES

V. Arjun, Mr. V.V. Ramakrishna, Mr. S. Rajasekhar, al. [2015], Thermal Analysis of an Engine Gasket at Different Operating Temperatures, Gasket sits between the engine block and cylinder head in an engine. Its purpose is to seal the cylinders to ensure maximum compression and avoid leakage of coolant or engine oil into the cylinders. From our project, we would like to modify the material and design of the gasket of four-cylinder engine.

M.Srikanth1 B.M. Balakrishnan2, al. [2015], Cylinder Head Gasket Analysis to Improve its Thermal Characteristics Using Advanced Fem Tool, Gasket sits between the engine block and cylinder head in an engine. Its purpose is to seal the cylinders to ensure maximum compression and avoid leakage of coolant or engine oil into the cylinders. From our project, we would like to modify the material and design of the gasket of four-cylinder engine. MLS or Multiple Layers Steel (These typically consist of three layers of steel) and asbestos – Most modern head engines are produced with MLS gaskets.

Dr M K Rodge et al (2016): In this paper we have considered the multilayer cylinder head gasket of single cylinder diesel engine for the analysis. Nonlinear analysis for the cylinder head gasket is performed to reduce the bore distortion as well as to

achieve the optimum contact pressure on the cylinder head gasket. Modelling has done in the CRE-O 2.0 and for the analysis ANSYS 15 software is used.

III METHODOLOGY USED

To obtain total deformation of the gasket we have taken four different materials having different properties. Materials that we selected is Stainless steel, Ceramic8D, FR-4 Epoxy, Steel 1008. With these materials we are going to analysing the thermal expansion of gasket and to find the thermal stress and temperature deformation, total heat flux and thermal error for these four materials of gasket, by comparing these four material results. distribution which material is good and cost reduction.

Materials Used in this study

Ceramic8D: A ceramic is an inorganic non-metallic solid made up of either metal or non-metal compounds that have been shaped and then hardened by heating to high temperatures. In general, they are hard, corrosion-resistant and brittle. Ceramics generally can withstand very high temperatures, ranging from 1,000 °C to 1,600 °C (1,800 °F to 3,000 °F).

FR-4 Epoxy: FR4 is a class of printed circuit board base material made from a flame-retardant epoxy resin and glass fabric composite. FR stands for flame retardant and meets the requirements of UL94V-0. FR4 has good adhesion to copper foil and has minimal water absorption, making it very suitable for standard applications.

Steel 1008: Steels containing mostly carbon as the alloying element are called carbon steels. They contain about 1.2% manganese and 0.4% silicon. Nickel, aluminium, chromium, copper and molybdenum are also present in small quantities in the carbon steels. AISI 1008 carbon steel has excellent weldability, which includes projection, butt, spot and fusion, and braze ability. It is primarily used in extruded, cold headed, cold upset, and cold pressed parts and forms.

Steel Stainless: Stainless steels are steels containing at least 10.5% chromium, less than 1.2% carbon and other alloying elements. Stainless steel's corrosion resistance and mechanical properties can be further enhanced by adding other elements, such as nickel, molybdenum, titanium, niobium, manganese, etc. This metal derives its name because it does not stain, rust or corrode, hence, called "STAINLESS STEEL".

Developed model in ANSYS software

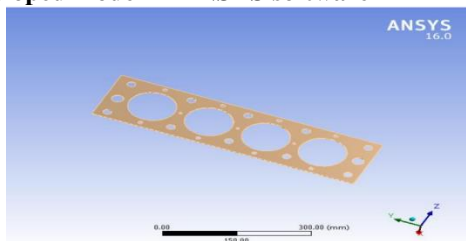

Fig 2: Gasket in ANSYS

IV RESULTS AND DISCUSSIONS

Material: Stainless steel

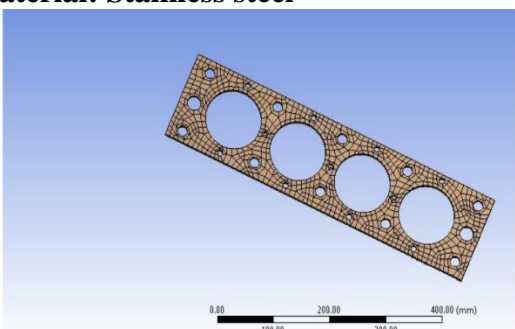

Fig 3: Mesh model

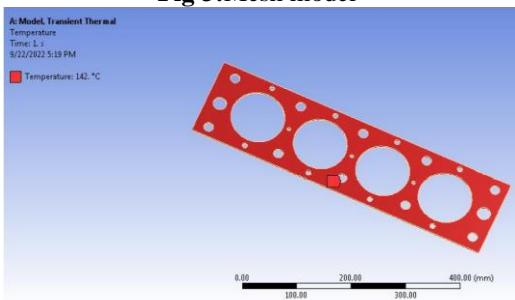

Fig 4: Temperature

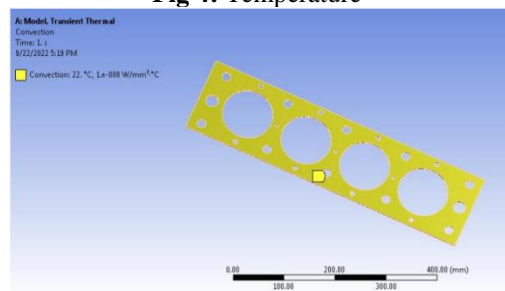
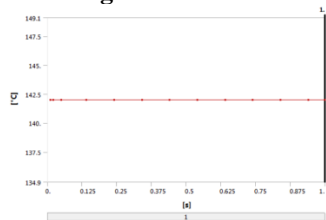
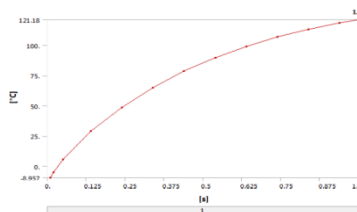

Fig 5: Convection



Graph 1: Temperature - Global Maximum vs Time



Graph 2: Temperature - Global Minimum vs Time
Table 1: Results(Stainless steel)

Object Name	Temperature	Total Heat Flux	Directional Heat Flux	Thermal Error
State	Solved			
Results				
Minimum	121.18 °C	8.9648e-007 W/mm ²	-0.28736 W/mm ²	1.2887e-004
Maximum	142. °C	0.28736 W/mm ²		29.437
Minimum Value Over Time				
Minimum	-8.957 °C	6.5039e-007 W/mm ²	-2.0832 W/mm ²	1.2887e-004
Maximum	121.18 °C	6.1425e-006 W/mm ²	-0.28736 W/mm ²	2.3113e-002
Maximum Value Over Time				
Minimum	142. °C	0.28736 W/mm ²		21.476
Maximum	142. °C	2.0832 W/mm ²		211.98
Information				
Time	1. s			

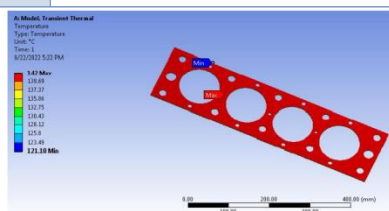
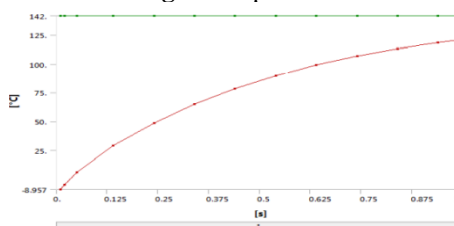

Fig 5: Temperature



Graph 3: Temperature Vs Time

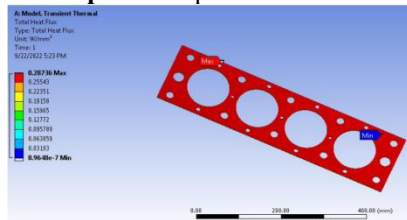
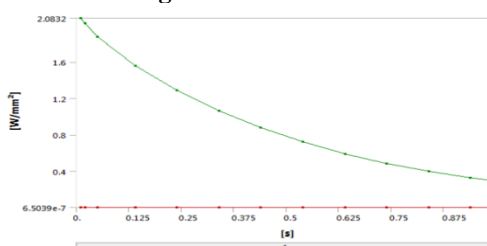

Fig 6: Total Heat Flux



Graph 4: Total Heat Flux vs time

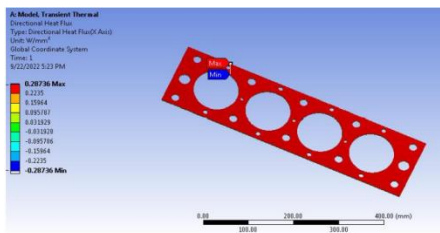
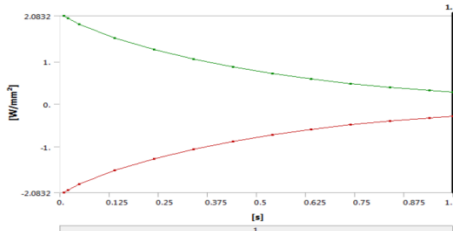

Fig 7: Directional Heat Flux



Graph 5: Temperature Vs Time

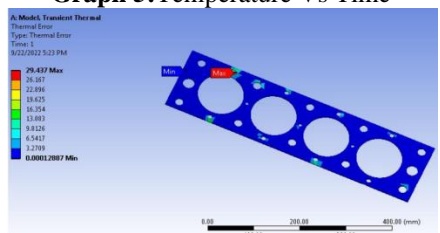
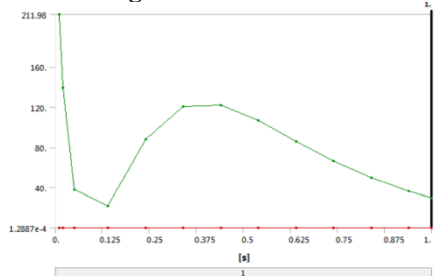

Fig 8: Thermal Error



Graph 6: Thermal Error Vs Time

Material: Steel 1008

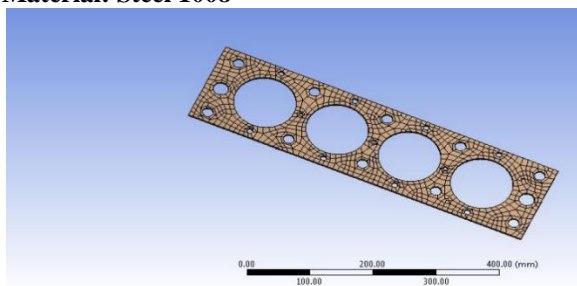

Fig 9: Mesh model for steel 1008

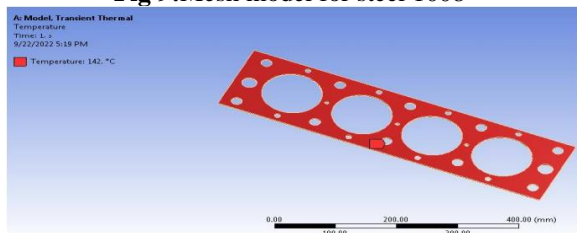

Fig 10: Temperature

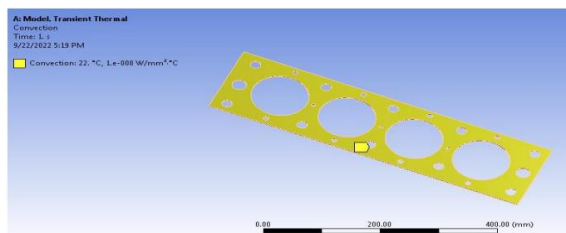
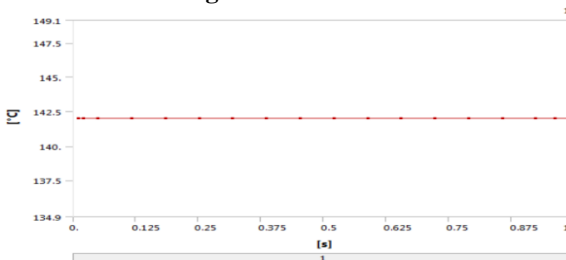
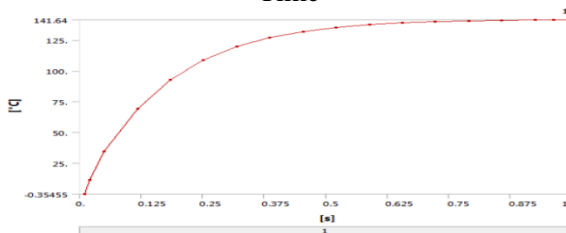

Fig 11: Convection



Graph 7: Temperature - Global Maximum vs Time



Graph 8: Temperature - Global Minimum vs Time

Table 2: Results (Steel 1008)

Object Name	Temperature	Total Heat Flux	Directional Heat Flux	Thermal Error
State	Solved			
Results				
Minimum	141.64 °C	3.0497e-008 W/mm²	-1.6108e-002 W/mm²	3.1384e-007
Maximum	142. °C	1.6108e-002 W/mm²		4.1479e-002
Minimum Value Over Time				
Minimum	-0.35455 °C	3.0497e-008 W/mm²	-6.406 W/mm²	3.1384e-007
Maximum	141.64 °C	1.4898e-005 W/mm²	-1.6108e-002 W/mm²	2.0446e-002
Maximum Value Over Time				
Minimum	142. °C	1.6108e-002 W/mm²		4.1479e-002
Maximum	142. °C	6.406 W/mm²	6.4059 W/mm²	336.07
Information				
Time	1. s			

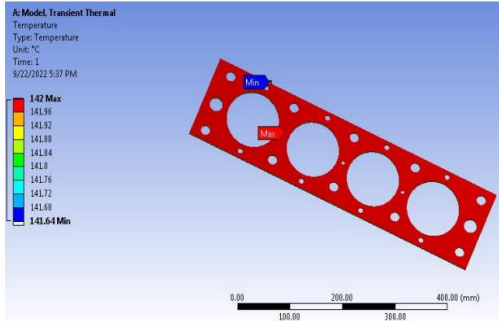
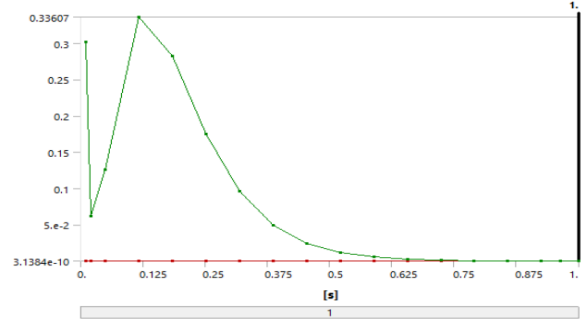
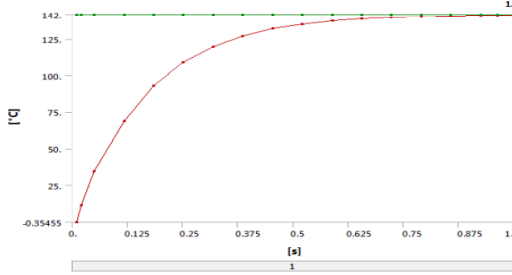

Fig 12: Temperature



Graph 11: Directional Heat Flux vs time



Graph 9: Temperature Vs Time

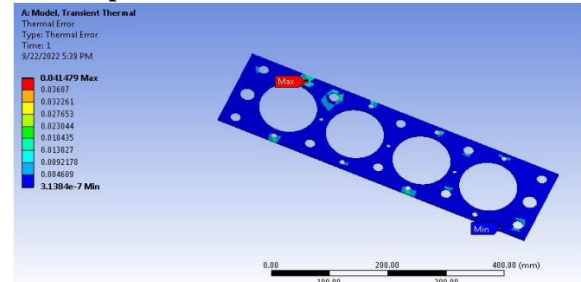

Fig 15: Thermal Error

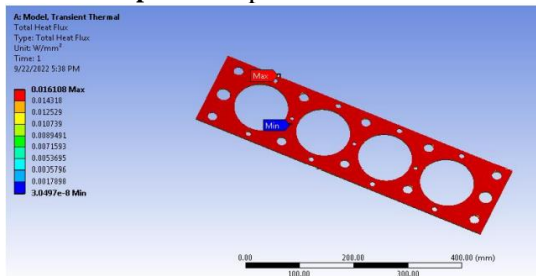
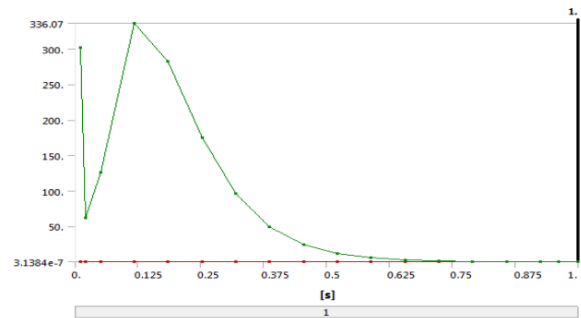
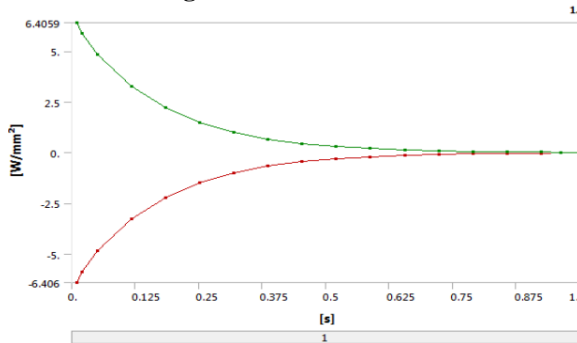

Fig 13: Total Heat Flux



Graph 12: Thermal Error Vs Time
Material: FR-4 Epoxy



Graph 10: Total Heat Flux vs time

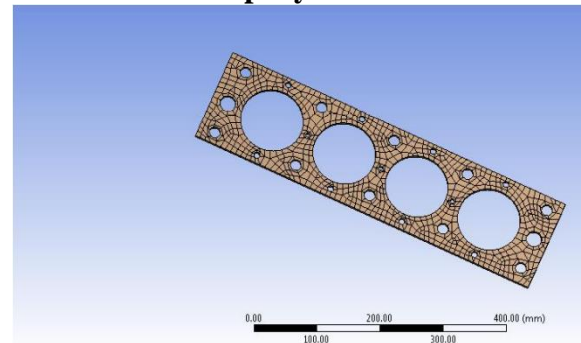

Fig 16: Mesh

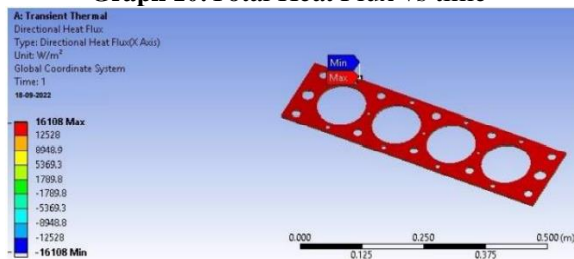

Fig 14: Directional Heat Flux

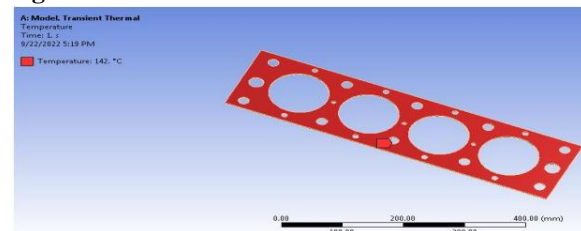

Fig 17: Temperature

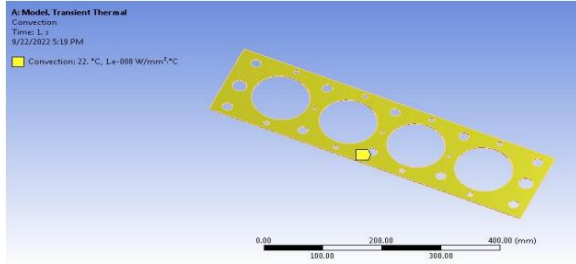
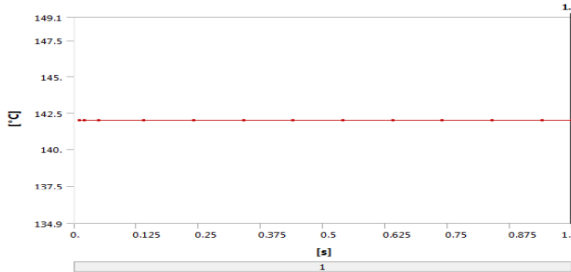
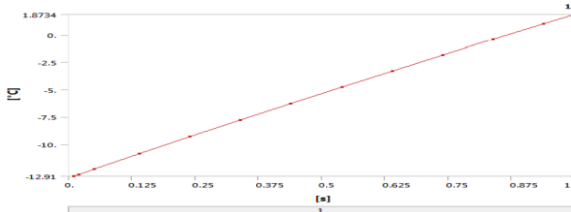

Fig 18: Convection



Graph 13: Temperature - Global Maximum vs Time



Graph 14: Temperature - Global Minimum vs time

Table 3: Results (FR-4 Epoxy)

Object Name	Temperature	Total Heat Flux	Directional Heat Flux	Thermal Error
Results				
Minimum	1.8734 °C	6.5119e-008 W/mm ²	-4.1197e-002 W/mm ²	2.3816e-004
Maximum	142. °C	4.1197e-002 W/mm ²		1.1897
Minimum Value Over Time				
Minimum	-12.91 °C	6.2922e-008 W/mm ²	-4.5544e-002 W/mm ²	1.4747e-004
Maximum	1.8734 °C	1.8495e-007 W/mm ²	-4.1197e-002 W/mm ²	1.074e-003
Maximum Value Over Time				
Minimum	142. °C	4.1197e-002 W/mm ²		1.1897
Maximum	142. °C	4.5544e-002 W/mm ²	4.5543e-002 W/mm ²	6.5877
Information				
Time	1. s			

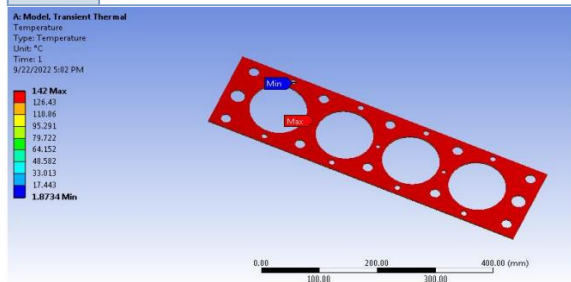
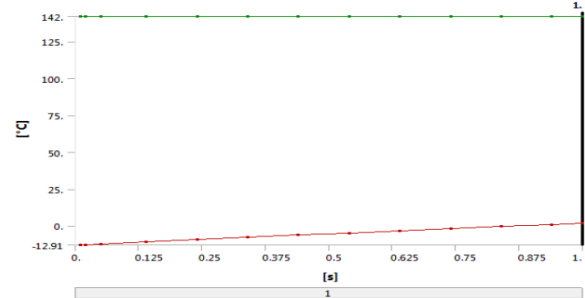

Fig 19: Temperature



Graph 15: Temperature Vs Time

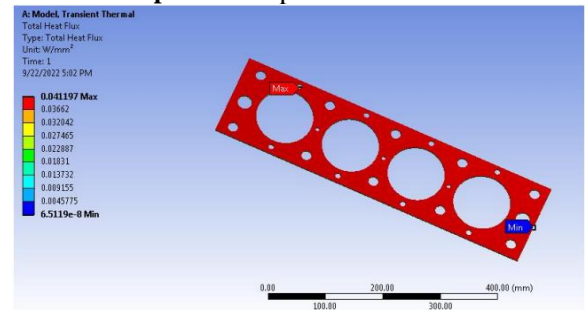
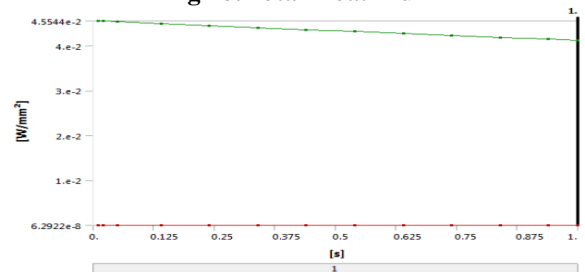

Fig 20: Total Heat Flux



Graph 16: Total Heat Flux vs time

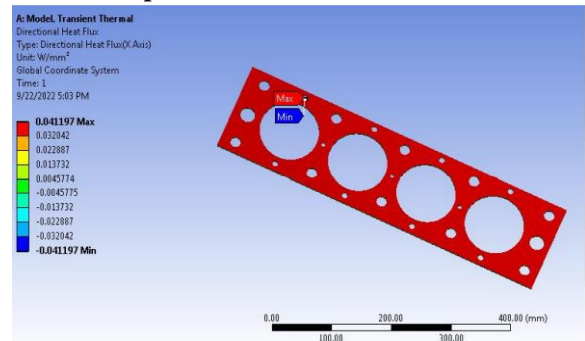
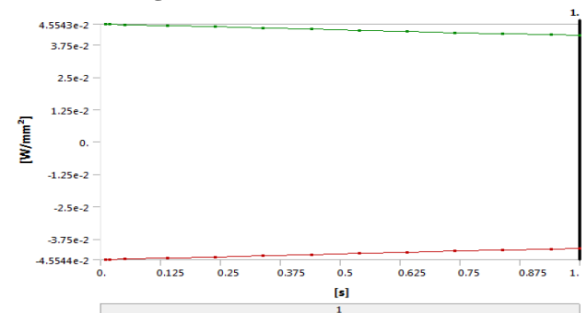

Fig 21: Directional Heat Flux



Graph 17: Directional Heat Flux Vs Time

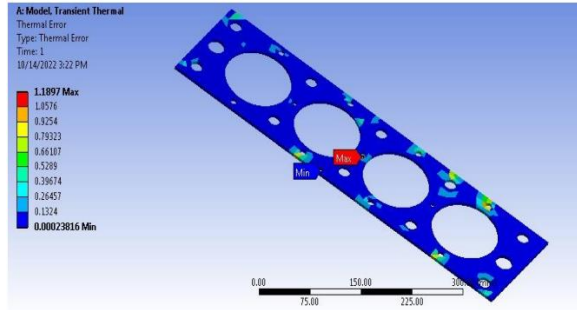
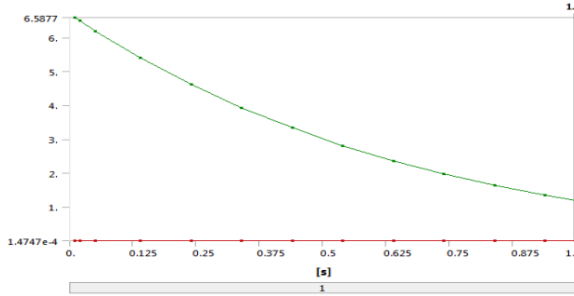

Fig 22: Thermal Error



Graph 18: Thermal Error Vs Time

Material : Ceramic8D

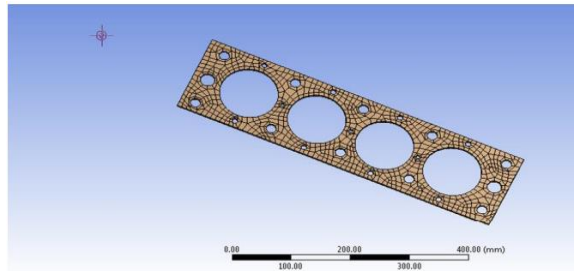

Fig 23: Mesh model

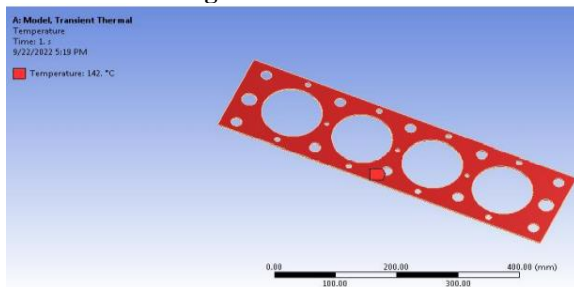

Fig 24: Temperature

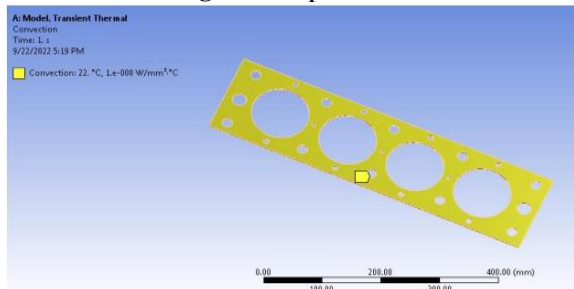
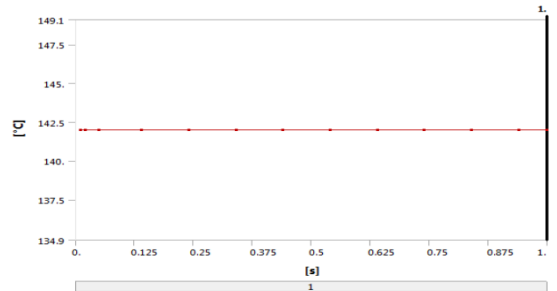
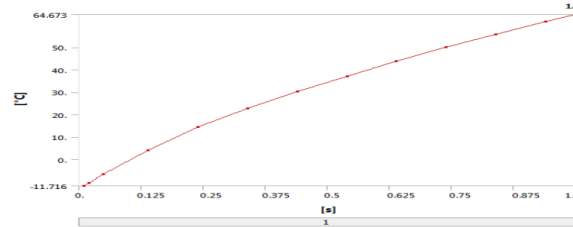

Fig 25: Convection



Graph 19: Temperature - Global Maximum vs Time



Graph 20: Temperature - Global Minimum vs Time

Table 4: Results (Ceramic8D)

Object Name	Temperature	Total Heat Flux	Directional Heat Flux	Thermal Error
State	Solved			
Results				
Minimum	64.673 °C	1.9279e-007 W/mm ²	-0.34797 W/mm ²	3.5659e-007
Maximum	142. °C	0.34798 W/mm ²	0.34797 W/mm ²	4.8677e-002
Minimum Value Over Time				
Minimum	-11.716 °C	1.7714e-007 W/mm ²	-0.69172 W/mm ²	3.1101e-007
Maximum	64.673 °C	2.5566e-006 W/mm ²	-0.34797 W/mm ²	1.4641e-005
Maximum Value Over Time				
Minimum	142. °C	0.34798 W/mm ²	0.34797 W/mm ²	3.7691e-003
Maximum	142. °C	0.69173 W/mm ²	0.69172 W/mm ²	8.9949e-002
Information				
Time	1. s			

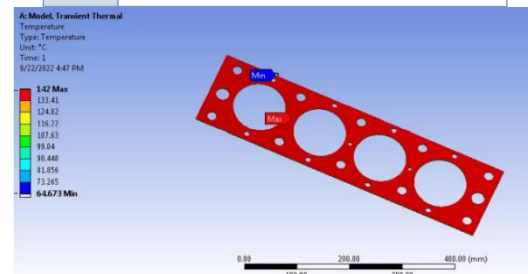
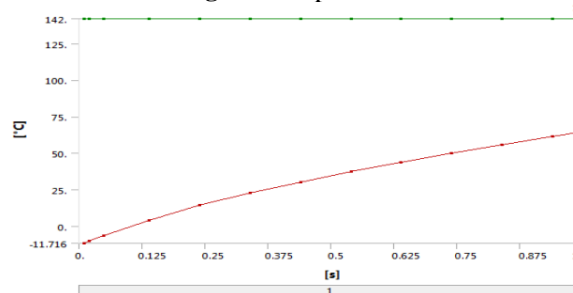

Fig 25: Temperature



Graph 21: Temperature Vs Time

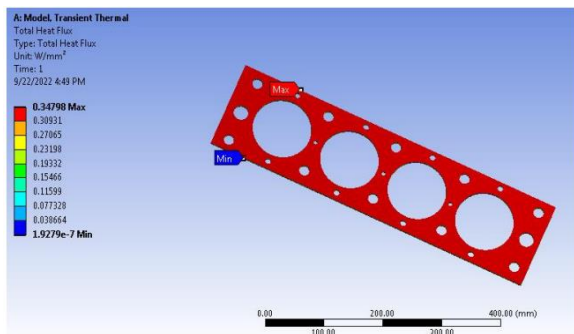
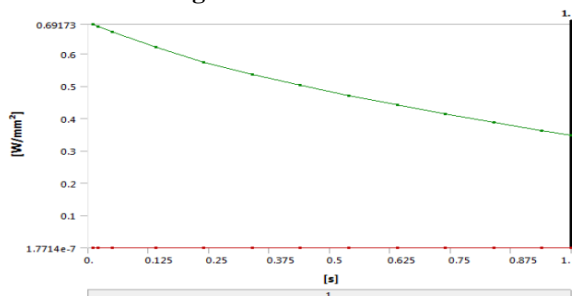

Fig 26: Total heat flux



Graph 22: Total Heat Flux vs time

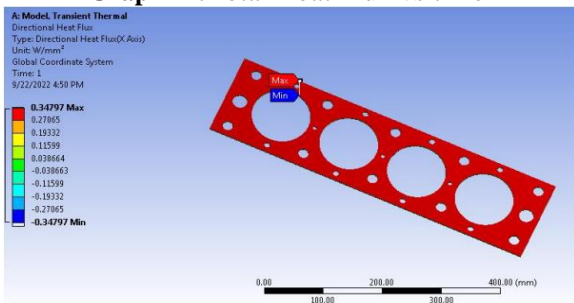
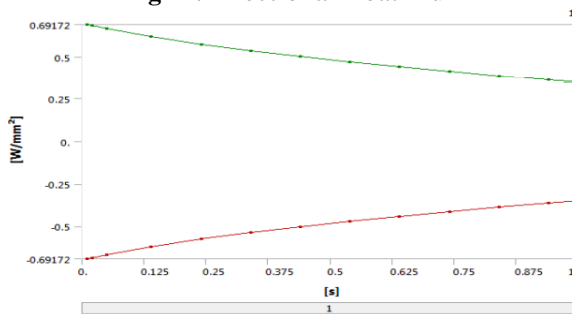

Fig 27: Directional Heat Flux



Graph 23: Directional Heat Flux Vs Time

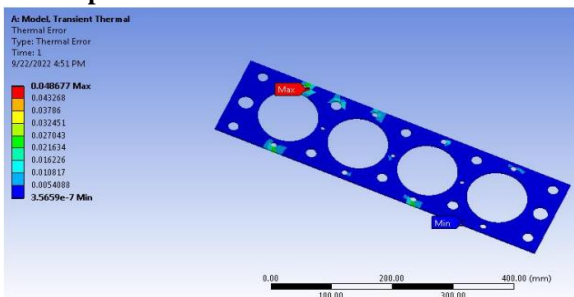
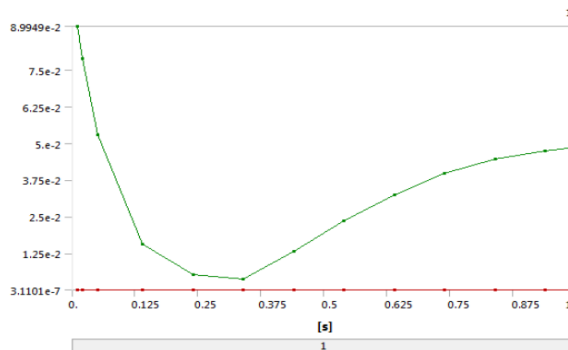

Fig 28: Thermal Error



Graph 24: Thermal Error Vs Time

Results and Comparison

Table 5: Ceramic8D Results

Object Name	Temperature	Total Heat Flux	Directional Heat Flux	Thermal Error
Results				
Minimum	64.673 °C	0.19279 W/m ²	-3.4797e+005 W/m ²	3.5659e-007
Maximum	142. °C	3.4798e+005 W/m ²	3.4797e+005 W/m ²	4.8677e-002

Table 6: FR-4 Epoxy Results

Object Name	Temperature	Total Heat Flux	Directional Heat Flux	Thermal Error
Results				
Minimum	1.8734 °C	6.5119e-002 W/m ²	-41197 W/m ²	2.3816e-007
Maximum	142. °C	41197 W/m ²		1.1897e-003

Table 7: Steel 1008

Object Name	Temperature	Total Heat Flux	Directional Heat Flux	Thermal Error
Results				
Minimum	141.64 °C	3.0497e-002 W/m ²	-16108 W/m ²	3.1384e-010
Maximum	142. °C	16108 W/m ²		4.1479e-005

Table 8: Steel Stainless

Object Name	Temperature	Total Heat Flux	Directional Heat Flux	Thermal Error
Results				
Minimum	121.18 °C	0.89648 W/m ²	-2.8736e+005 W/m ²	1.2887e-007
Maximum	142. °C	2.8736e+005 W/m ²		2.9437e-002

VCONCLUSIONS

This project successfully analysed thermal state of cylinder head gasket made up of Steel Stainless and Ceramic8D, FR-4 Epoxy, Steel 1008 material. By comparing the above results, Steel 1008 can withstand in high temperatures and also the heat flux is also low. At the high temperature and low heat flux the thermal error is suitable for making the head gaskets. By this we have concluded that Steel 1008 can be the best material to use as alternative material. This will reduce the breakages of the gasket and increase the life span of the engine.

By analysing the sealing performance of cylinder head gasket by various material. It is possible to improve the sealing joints. This will reduce the cost, development time and improve reliability of gasket and engine performance. In further enhancements by using this project.

The temperature is not only the reason for the deformation of gasket. The pressure acting inside the cylinder is also a reason for deformation of the gasket.

REFERENCES

[1] Mr. V.V. Ramakrishna, Mr. S. Rajasekhar, (December 2015) "Thermal Analysis of an Engine Gasket At Different Operating Temperatures" issue 12, ISSN 2348 – 4845.

[2] G.P. Blair, C.D. McCartan, H. Hermann, (July 2005) "The Right Lift", Race Engine Technology, issue 009, ISSN 1740 -6803

[3] T.Belytschko, W.K. Liu, B.Moran,(2010) Nonlinear Finite Elements for Continua and Structures, Wiley, New York, 2000pp. 569 -613.

[4] Bormane, G., Nishiwaki, K. (2011) "Internal Combustion Engine Heat Transfer", ProgEnergycombustion Science, vol.13, PP.1 -46.

[5] B. Corona, M. Nakano, H. Pérez, (2007) "Adaptive Watermarking Algorithm for Binary Image Watermarks", Lecture Notes in Computer Science, Springer, pp. 207 -215.

[6] S.K. Chan, I.S. Tuba, (2008) A finite element method for contact problem of solid bodies part -1, theory and validation, Int. J. Mech. Sci. 18 (13) 615 - 625.

[7] , A. K., Laxmaiah, G., & Babu, P. R. Process Parameters Optimization And Characterization Of RTM Manufacturing Process For High Performance Composites.

[8] F.Macek Heat,(2003) "Analysis of Engine Head gasket", Abstracts of 20th DanubiaAdria Symposium on Experimental Methods in Solid Mechanics. University of Applied Sciences, s. 74 - 75. ISBN 963 -9058 -20.

[9] J.Montgomery, (2002) Methods for modeling bolts in the bolted joint, ANSYS User's Conference.

[10] A.R.Mijar, J.S. Arora,(2008) review of formulations for elastostatic frictional contact problems, Struct. Multidiscip.Optim.167 -189.

[11] S.Othe,(2008) Finite element analysis of elastic contact problems, Bull. JSME 16 (95) 797 -804.

[12] Raub, J. H. (2006), "Structural Analysis of Diesel Engine Cylinder Head Gasket Joints," SAE Paper 921725